

# GCSE Mathematics

## Practice Tests: Set 9

### Paper 1H (Non-calculator)

**Time: 1 hour 30 minutes**

You should have: Ruler graduated in centimetres and millimetres, protractor, pair of compasses, pen, HB pencil, eraser, calculator. Tracing paper may be used.

#### Instructions

- Use **black** ink or ball-point pen.
- **Fill in the boxes** at the top of this page with your name, centre number and candidate number.
- Answer **all** questions.
- Answer the questions in the spaces provided  
– *there may be more space than you need.*
- **Calculators may be used.**
- Diagrams are NOT accurately drawn, unless otherwise indicated.
- You must **show all your working out.**



#### Information

- The total mark for this paper is 80
- The marks for **each** question are shown in brackets  
– *use this as a guide as to how much time to spend on each question.*

#### Advice

- Read each question carefully before you start to answer it.
- Keep an eye on the time.
- Try to answer every question.
- Check your answers if you have time at the end.

Answer ALL questions.

Write your answers in the spaces provided.

You must write down all the stages in your working.

1 Here is a hexagon  $ABCDEF$ .

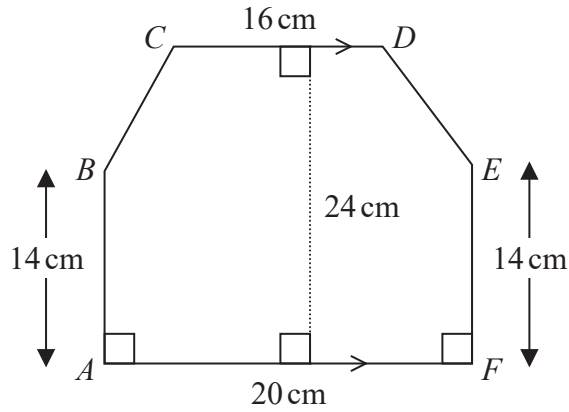

Diagram NOT accurately drawn

$CD$  is parallel to  $AF$ .

Work out the area of hexagon  $ABCDEF$ .

.....  $\text{cm}^2$

(Total for Question 1 is 4 marks)

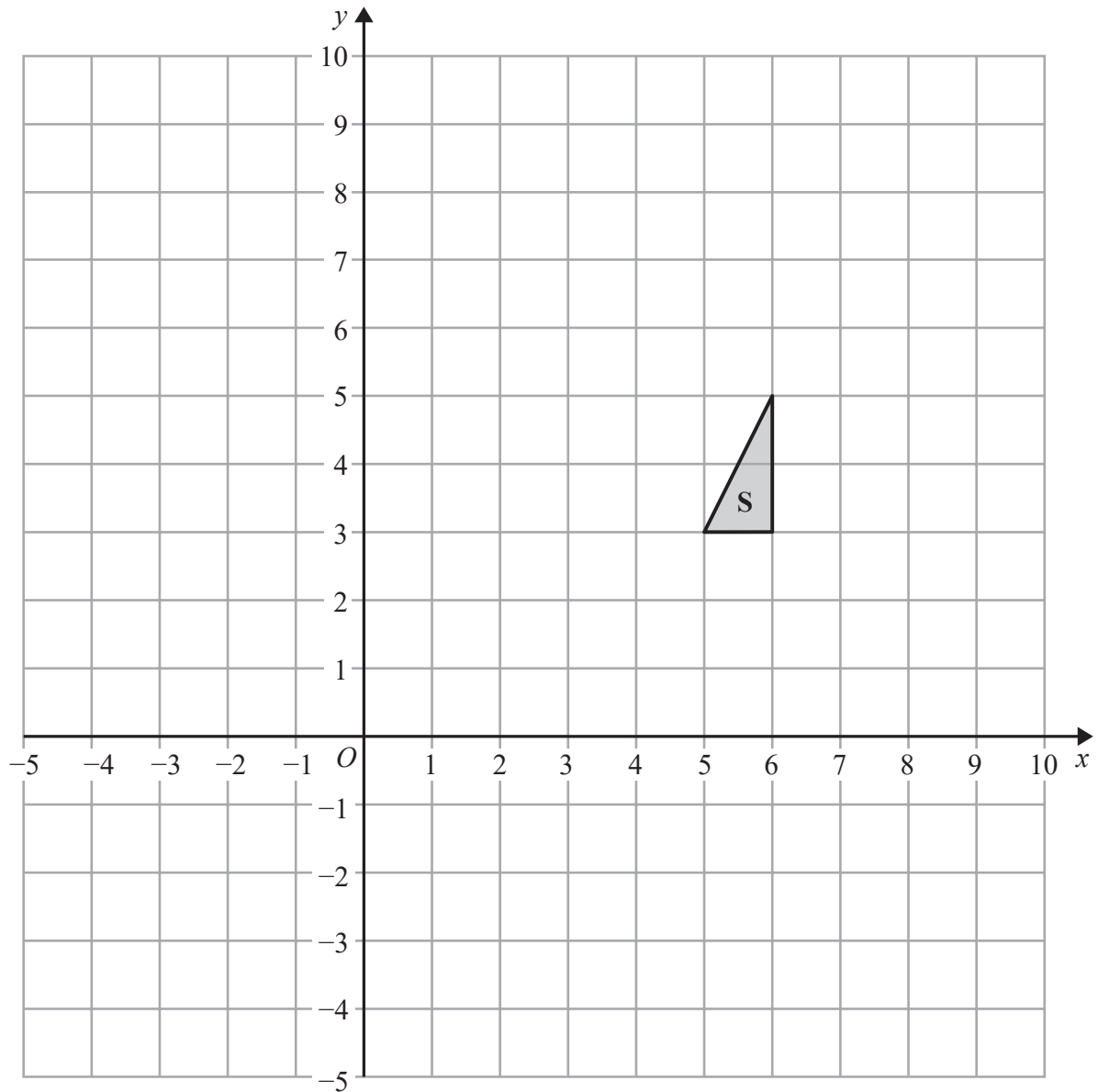

- (a) Reflect triangle **S** in the line  $y = x$   
Label the new triangle **R**.

(2)

- (b) Translate triangle **S** by the vector  $\begin{pmatrix} -4 \\ -6 \end{pmatrix}$   
Label the new triangle **T**.

(1)

(Total for Question 2 is 3 marks)

**3**  $E = n^2 + n + 5$

Ali thinks that the value of  $E$  will be a prime number for any whole number value of  $n$ .

Is Ali correct?

You must give a reason for your answer.

.....  
.....

**(Total for Question 3 is 2 marks)**

---

4

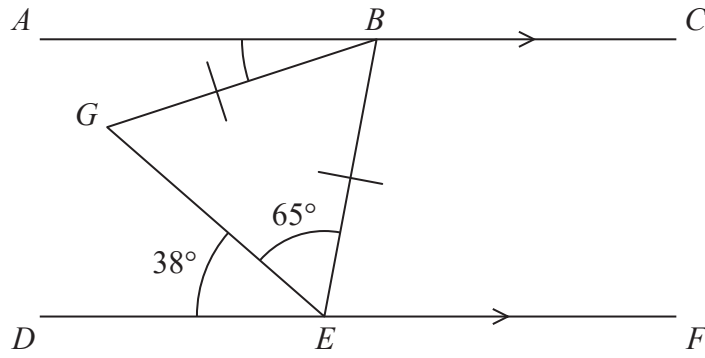

Diagram **NOT** accurately drawn

$ABC$  and  $DEF$  are parallel lines.

$BG = BE$

Angle  $DEG = 38^\circ$

Angle  $GEB = 65^\circ$

Find the size of angle  $ABG$ .

.....<sup>o</sup>

**(Total for Question 4 is 3 marks)**

---

5 Here are the first four terms of an arithmetic sequence.

6            10            14            18

(a) Find an expression, in terms of  $n$ , for the  $n$ th term of this sequence.

.....  
(2)

(b) Write down an expression, in terms of  $n$ , for the  $(n + 1)$ th term of this sequence.

.....  
(1)

**(Total for Question 5 is 3 marks)**

---

6 (a) Simplify fully  $\frac{20x^2y^6}{4x^2y^2}$

.....  
(2)

(b) Make  $e$  the subject of the formula  $h = 3e + f$

.....  
(2)

**(Total for Question 6 is 4 marks)**

---

7 (a) Write 1 390 000 in standard form.

.....  
(1)

(b) Write 0.005 in standard form.

.....  
(1)

**(Total for Question 7 is 2 marks)**

---

8 Solve

$$\begin{aligned}3x + 2y &= 15 \\10x - 4y &= 2\end{aligned}$$

Show clear algebraic working.

$$x = \dots\dots\dots$$

$$y = \dots\dots\dots$$

**(Total for Question 8 is 3 marks)**

---



9

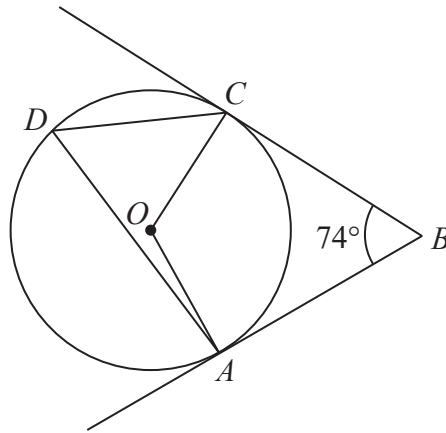

Diagram **NOT**  
accurately drawn

$A$ ,  $C$  and  $D$  are points on a circle, centre  $O$ .  
 $AB$  and  $CB$  are tangents to the circle.

Angle  $ABC = 74^\circ$

Work out the size of angle  $ADC$ .  
Show your working clearly.

.....<sup>o</sup>  
**(Total for Question 9 is 3 marks)**

**10** Each month Edna spends all her income on rent, on travel and on other living expenses.

She spends  $\frac{1}{3}$  of her income on rent.

She spends  $\frac{1}{5}$  of her income on travel.

She spends \$420 of her income on other living expenses.

Work out her income each month.

\$.....

**(Total for Question 10 is 4 marks)**

---

**11**  $128 = 4^{2x} \times 2^x$

Work out the value of  $x$ .

$x = \dots\dots\dots$

**(Total for Question 11 is 3 marks)**

---

12 (a) Simplify  $(2e^2 f^3)^3$

.....  
(2)

(b) Expand and simplify  $(3x - 4y)(x + 3y)$

.....  
(2)

$\frac{\sqrt{a} \times a}{a^{-2}}$  can be written in the form  $a^k$

(c) Find the value of  $k$ .

$k =$  .....  
(2)

(d) Simplify  $\frac{2^n - 1}{4^n - 1}$

.....  
(2)

**(Total for Question 12 is 8 marks)**

13 There are two bags of counters, bag X and bag Y.

There are 20 counters in bag X.

11 of the counters are blue and the rest are red.

There are 16 counters in bag Y.

9 of the counters are blue and the rest are red.

Arkady takes at random a counter from bag X and takes at random a counter from bag Y.

(a) Complete the probability tree diagram.

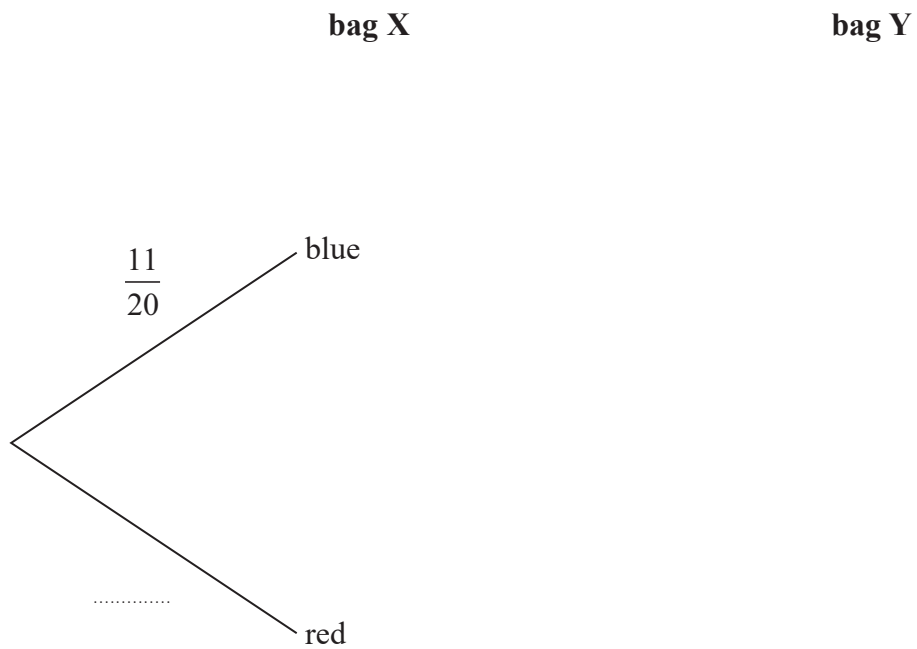

(3)

(b) Work out the probability that the two counters are both red.

.....  
(2)

(c) Work out the probability that the two counters are both red or are both blue.

.....  
(3)

**(Total for Question 13 is 8 marks)**

---

14 The table gives information about the areas, in hectares, of some farms in Spain.

Area ( $A$ hectares)	Frequency
$0 < A \leq 20$	40
$20 < A \leq 50$	90
$50 < A \leq 100$	140
$100 < A \leq 300$	140
$300 < A \leq 350$	40

On the grid, draw a histogram for this information.

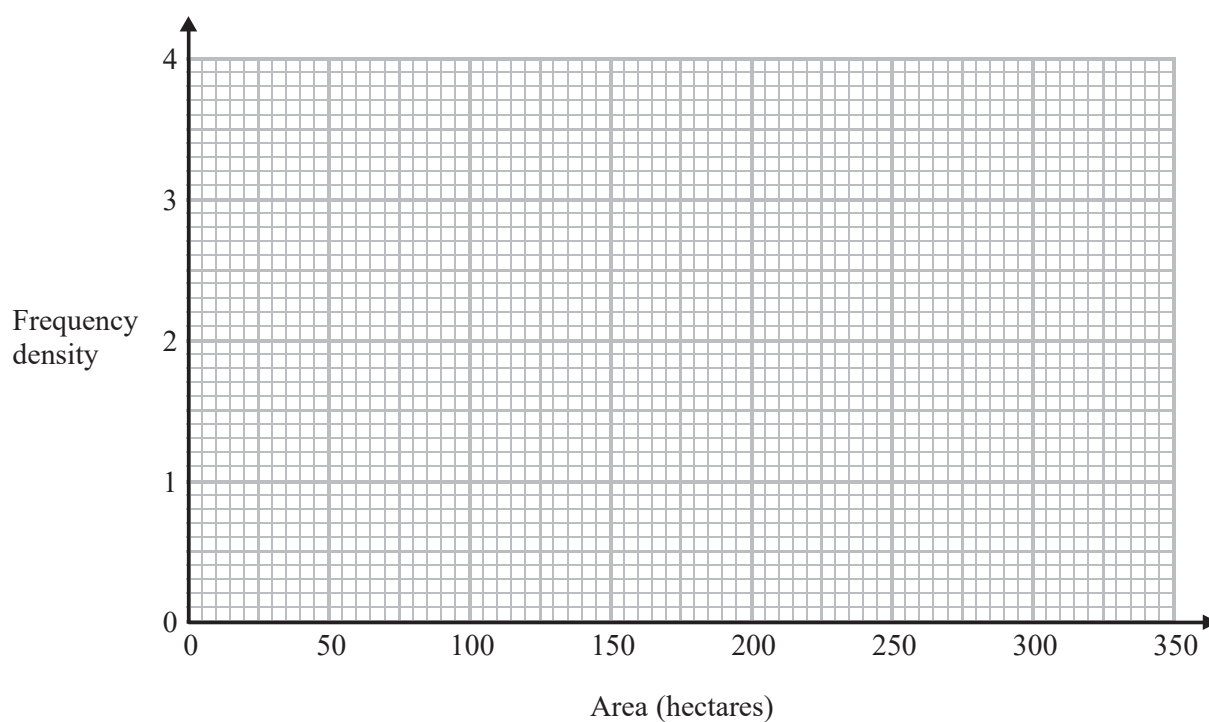

(Total for Question 14 is 3 marks)

**15** (a) Use algebra to show that  $0.4\dot{3}\dot{6} = \frac{24}{55}$

(2)

(b) Show that  $\frac{\sqrt{20} + \sqrt{80}}{\sqrt{3}}$  can be expressed in the form  $\sqrt{a}$  where  $a$  is an integer.

Show your working clearly.

(3)

(Total for Question 15 is 5 marks)

---



**16** Two functions,  $f$  and  $g$  are defined as

$$f : x \mapsto 1 + \frac{1}{x} \quad \text{for } x > 0$$

$$g : x \mapsto \frac{x+1}{2} \quad \text{for } x > 0$$

Given that  $h = fg$

express the inverse function  $h^{-1}$  in the form  $h^{-1} : x \mapsto \dots$

$$h^{-1} : x \mapsto \dots$$

**(Total for Question 16 is 4 marks)**

---

17 Here is the graph of  $y = f(x)$

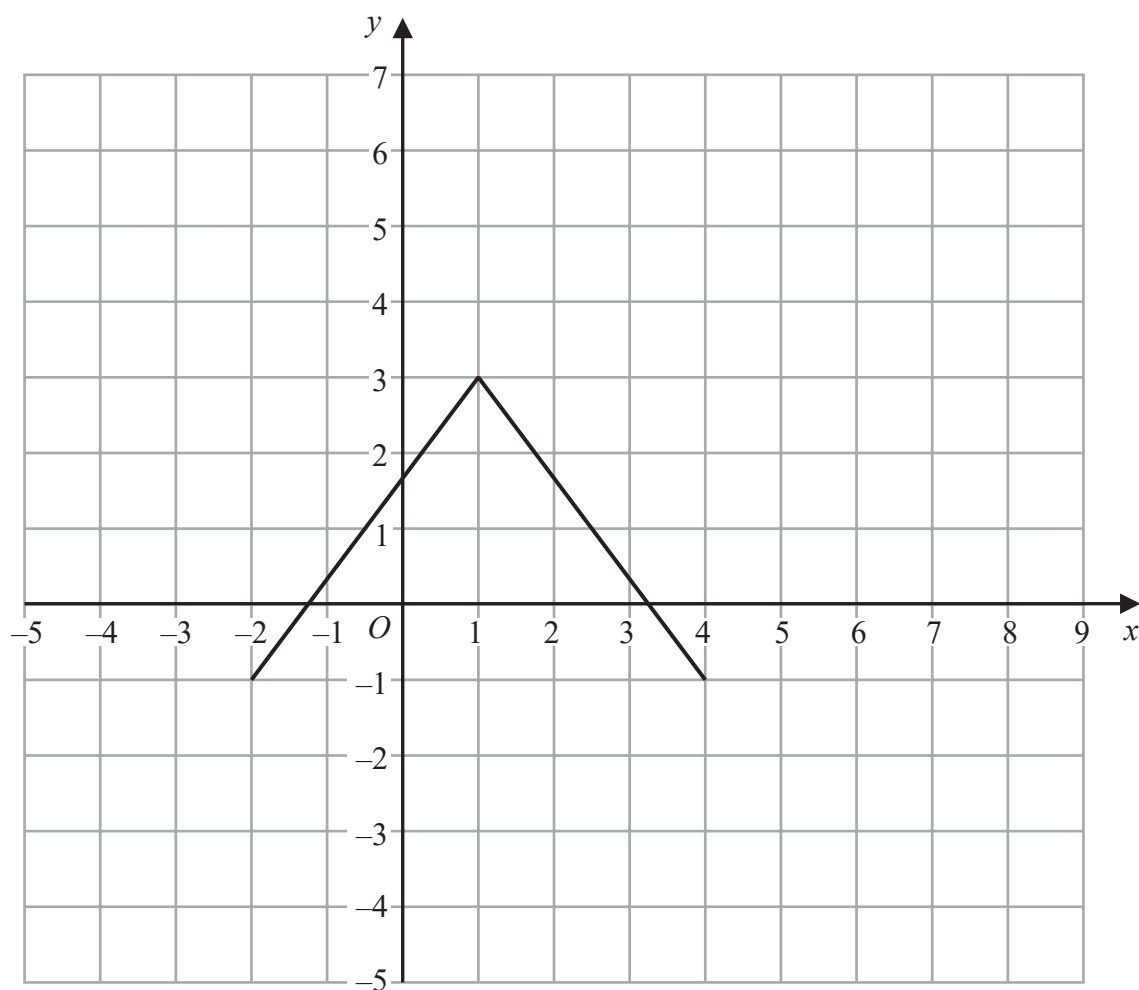

(a) On the grid above, draw the graph of  $y = 2 + f(x)$

(2)

Here is the graph of  $y = f(x)$

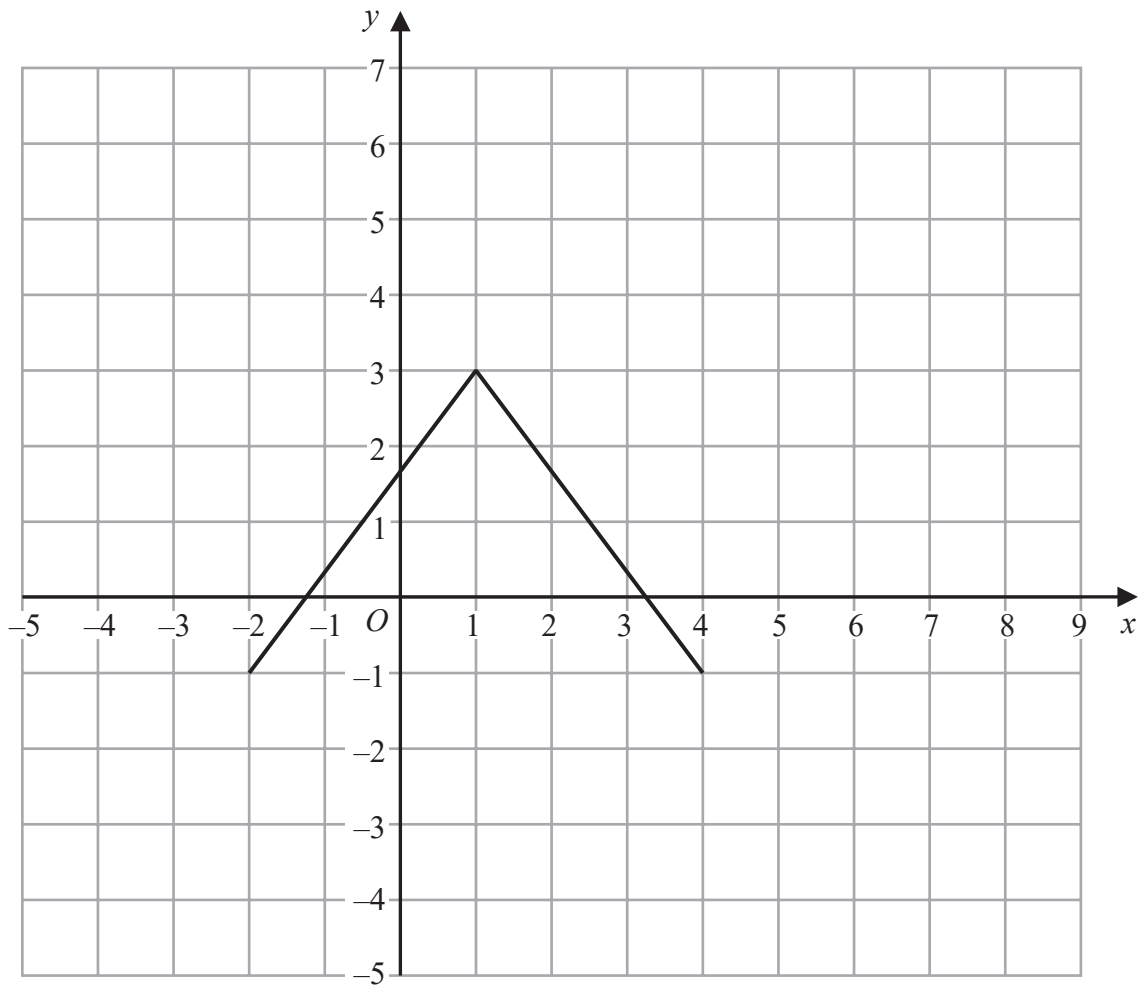

(b) On the grid above, draw the graph of  $y = f(-x)$

(2)

(Total for Question 17 is 4 marks)

---

**18** (a) Show that  $x(x - 1)(x + 1) = x^3 - x$

(1)

(b) Prove that the difference between a whole number and the cube of this number is always a multiple of 6.

(3)

(Total for Question 18 is 4 marks)

---

*[This question wouldn't appear on a GCSE (9-1) paper but it's been left in as a challenge problem to solve!]*

**19** Work out the sum of the multiples of 3 between 1 and 1000.

.....  
(Total for Question 19 is 4 marks)

---

**TOTAL FOR PAPER IS 80 MARKS**

**BLANK PAGE**